



# 775XFire-eSATA2+

## User Manual

Version 1.0

Published April 2006

Copyright©2006 ASRock INC. All rights reserved.

---

### **Copyright Notice:**

No part of this manual may be reproduced, transcribed, transmitted, or translated in any language, in any form or by any means, except duplication of documentation by the purchaser for backup purpose, without written consent of ASRock Inc.

Products and corporate names appearing in this manual may or may not be registered trademarks or copyrights of their respective companies, and are used only for identification or explanation and to the owners' benefit, without intent to infringe.

### **Disclaimer:**

Specifications and information contained in this manual are furnished for informational use only and subject to change without notice, and should not be constructed as a commitment by ASRock. ASRock assumes no responsibility for any errors or omissions that may appear in this manual.

With respect to the contents of this manual, ASRock does not provide warranty of any kind, either expressed or implied, including but not limited to the implied warranties or conditions of merchantability or fitness for a particular purpose.

In no event shall ASRock, its directors, officers, employees, or agents be liable for any indirect, special, incidental, or consequential damages (including damages for loss of profits, loss of business, loss of data, interruption of business and the like), even if ASRock has been advised of the possibility of such damages arising from any defect or error in the manual or product.



This device complies with Part 15 of the FCC Rules. Operation is subject to the following two conditions:

- (1) this device may not cause harmful interference, and
- (2) this device must accept any interference received, including interference that may cause undesired operation.

**ASRock Website:** <http://www.asrock.com>

---

# Contents

<b>1 Introduction .....</b>	<b>5</b>
1.1 Package Contents .....	5
1.2 Specifications .....	6
1.3 Minimum Hardware Requirement Table for Windows® Vista™ Premium and Basic Logo.....	9
1.4 Supported PCI Express VGA Card List for AGI Express Slot (PCI Express x4) .....	10
1.5 Motherboard Layout .....	11
1.6 ASRock 8CH_eSATAII I/O .....	12
<b>2 Installation.....</b>	<b>13</b>
2.1 Screw Holes .....	13
2.2 Pre-installation Precautions .....	13
2.3 CPU Installation .....	14
2.4 Installation of Heatsink and CPU fan .....	16
2.5 Installation of Memory Modules (DIMM).....	17
2.6 Expansion Slots .....	19
2.7 CrossFire™ Operation Guide .....	20
2.8 Surround Display Feature .....	24
2.9 Jumpers Setup .....	24
2.10 Onboard Headers and Connectors .....	24
2.11 HDMI_SPDIF Header Connection Guide .....	30
2.12 eSATAII Interface Introduction .....	31
2.13 SATAII Hard Disk Setup Guide .....	34
2.14 Serial ATA (SATA) / Serial ATAII (SATAII) Hard Disks Installation .....	35
2.15 Hot Plug and Hot Swap Functions for SATA / SATAII ... HDDs and eSATAII Devices .....	36
2.16 Driver Installation Guide .....	36
2.17 Installing Windows® 2000 / XP / XP 64-bit / Vista™ With RAID Functions .....	37
2.17.1 Setting Up a RAID Ready System .....	38
2.17.2 Migrating a "RAID Ready" System to RAID 0, RAID 1 or RAID 5 .....	39
2.18 Installing Windows® 2000 / XP / XP 64-bit / Vista™ Without RAID Functions .....	39
2.19 Untied Overclocking Technology .....	40
<b>3 BIOS SETUP UTILITY.....</b>	<b>41</b>
3.1 Introduction .....	41

---

3.1.1 BIOS Menu Bar .....	41
3.1.2 Navigation Keys .....	42
3.2 Main Screen .....	42
3.3 Advanced Screen .....	42
3.3.1 CPU Configuration .....	43
3.3.2 Chipset Configuration .....	45
3.3.3 ACPI Configuration .....	47
3.3.4 IDE Configuration .....	48
3.3.5 PCI/PnP Configuration .....	50
3.3.6 Floppy Configuration .....	51
3.3.7 Super IO Configuration .....	51
3.3.8 USB Configuration .....	53
3.4 Hardware Health Event Monitoring Screen .....	53
3.5 Boot Screen .....	54
3.5.1 Boot Settings Configuration .....	55
3.6 Security Screen .....	55
3.7 Exit Screen .....	56
<b>4 Software Support .....</b>	<b>57</b>
4.1 Install Operating System .....	57
4.2 Support CD Information .....	57
4.2.1 Running Support CD .....	57
4.2.2 Drivers Menu .....	57
4.2.3 Utilities Menu .....	57
4.2.4 "LGA 775 CPU Installation Live Demo" Program ..	57
4.2.5 Contact Information .....	57

---

## Chapter 1 Introduction

Thank you for purchasing ASRock 775XFire-eSATA2+ motherboard, a reliable motherboard produced under ASRock's consistently stringent quality control. It delivers excellent performance with robust design conforming to ASRock's commitment to quality and endurance.

In this manual, chapter 1 and 2 contain introduction of the motherboard and step-by-step guide to the hardware installation. Chapter 3 and 4 contain the configuration guide to BIOS setup and information of the Support CD.



Because the motherboard specifications and the BIOS software might be updated, the content of this manual will be subject to change without notice. In case any modifications of this manual occur, the updated version will be available on ASRock website without further notice. You may find the latest VGA cards and CPU support lists on ASRock website as well. ASRock website <http://www.asrock.com>

### 1.1 Package Contents

ASRock 775XFire-eSATA2+ Motherboard

(ATX Form Factor: 12.0-in x 8.6-in, 30.5 cm x 21.8 cm)

ASRock 775XFire-eSATA2+ Quick Installation Guide

ASRock 775XFire-eSATA2+ Support CD

(including *LGA 775 CPU Installation Live Demo*)

One 80-conductor Ultra ATA 66/100 IDE Ribbon Cable

One Ribbon Cable for a 3.5-in Floppy Drive

Four Serial ATA (SATA) Data Cables (Optional)

Two Serial ATA (SATA) HDD Power Cables (Optional)

One HDMI\_SPDIF Cable (Optional)

One ASRock 8CH\_eSATAII I/O Panel Shield

One USB Bracket

## 1.2 Specifications

<b>Platform</b>	- ATX Form Factor: 12.0-in x 8.6-in, 30.5 cm x 21.8 cm
<b>CPU</b>	- LGA 775 for Intel® Dual Core Pentium® D / Pentium® 4 / Celeron® D, supporting Conroe, Presler and Cedar Mill processors (in 775-land LGA package) - FSB 800/533 MHz - Supports Hyper-Threading Technology (see <b>CAUTION 1</b> ) - Supports Untied Overclocking Technology (see <b>CAUTION 2</b> ) - Supports EM64T CPU
<b>Chipset</b>	- Northbridge: Intel® 945PL chipset - Southbridge: Intel® ICH7R
<b>Memory</b>	- Dual Channel DDRII Memory Technology (see <b>CAUTION 3</b> ) - 4 x DDRII DIMM slots - Support DDRII533 (see <b>CAUTION 4</b> ) - Max. capacity: 2GB
<b>Hybrid Booster</b>	- CPU Frequency Stepless Control (see <b>CAUTION 5</b> ) - ASRock U-COP (see <b>CAUTION 6</b> ) - Boot Failure Guard (B.F.G.)
<b>Expansion Slot</b>	- Supports ATI® CrossFire™ - 3 x PCI slots - 1 x PCI Express x16 slot - 1 x AGI Express slot (PCI Express x4) (see <b>CAUTION 7</b> ) - 1 x PCI Express x1 slot
<b>Audio</b>	- Realtek ALC888 7.1 channel CODEC with High Definition Audio
<b>LAN</b>	- Realtek PCI LAN 8101L - Speed: 10/100 Ethernet - Supports Wake-On-LAN
<b>Rear Panel I/O</b>	ASRock 8CH_eSATAII I/O - 1 x PS/2 Mouse Port - 1 x PS/2 Keyboard Port - 1 x Serial Port: COM1 - 1 x Parallel Port (ECP/EPP Support) - 2 x Ready-to-Use USB 2.0 Ports - 2 x eSATAII Ports - 1 x RJ-45 LAN Port - HD Audio Jack: Side Speaker/Rear Speaker/Central Bass/Line in/Front Speaker/Microphone (see <b>CAUTION 8</b> )

<b>Connector</b>	<ul style="list-style-type: none"> <li>- 4 x Serial ATAII 3.0Gb/s connectors, support RAID (RAID 0, RAID 1, RAID 10, RAID 5, and Intel Matrix Storage), NCQ, AHCI and "Hot Plug" functions (see <b>CAUTION 9</b>)</li> <li>- 2 x eSATAII 3.0Gb/s connectors (shared with 2 SATAII connectors), support "Hot Plug" function (see <b>CAUTION 10</b>)</li> <li>- 1 x ATA100 IDE connector (supports 2 x IDE devices)</li> <li>- 1 x Floppy connector</li> <li>- 1 x IR header</li> <li>- 1 x Game header</li> <li>- 1 x HDMI_SPDIF header</li> <li>- CPU/Chassis FAN connector</li> <li>- 20 pin ATX power connector</li> <li>- 4 pin 12V power connector</li> <li>- SLI/XFIRE power connector</li> <li>- CD in header</li> <li>- Front panel audio connector</li> <li>- 3 x USB 2.0 headers (support 6 USB 2.0 ports) (see <b>CAUTION 11</b>)</li> </ul>
<b>BIOS Feature</b>	<ul style="list-style-type: none"> <li>- 4Mb AMI BIOS</li> <li>- AMI Legal BIOS</li> <li>- Supports "Plug and Play"</li> <li>- ACPI 1.1 Compliance Wake Up Events</li> <li>- Supports jumperfree</li> <li>- SMBIOS 2.3.1 Support</li> </ul>
<b>Support CD</b>	- Drivers, Utilities, AntiVirus Software (Trial Version)
<b>Hardware Monitor</b>	<ul style="list-style-type: none"> <li>- CPU Temperature Sensing</li> <li>- Chassis Temperature Sensing</li> <li>- CPU Fan Tachometer</li> <li>- Chassis Fan Tachometer</li> <li>- CPU Quiet Fan</li> <li>- Voltage Monitoring: +12V, +5V, +3.3V, Vcore</li> </ul>
<b>OS</b>	- Microsoft® Windows® 2000/XP/XP 64-bit/Vista™ compliant (see <b>CAUTION 12</b> )
<b>Certifications</b>	- FCC, CE, WHQL

## **CAUTION!**

1. About the setting of "Hyper Threading Technology", please check page 44.
2. This motherboard supports Untied Overclocking Technology. Please read "Untied Overclocking Technology" on page 40 for details.
3. This motherboard supports Dual Channel Memory Technology. Before you implement Dual Channel Memory Technology, make sure to read the installation guide of memory modules on page 17 for proper installation.
4. There are memory module installation limitations on this motherboard, please read "Installation of Memory Modules (DIMM)" on page 17 for details.
5. Although this motherboard offers stepless control, it is not recommended to perform over-clocking. Frequencies other than the recommended CPU bus frequencies may cause the instability of the system or damage the CPU.
6. While CPU overheat is detected, the system will automatically shutdown. Before you resume the system, please check if the CPU fan on the motherboard functions properly and unplug the power cord, then plug it back again. To improve heat dissipation, remember to spray thermal grease between the CPU and the heatsink when you install the PC system.
7. For the information of the compatible PCI Express VGA cards, please refer to the "Supported PCI Express VGA Card List for AGI Express Slot (PCI Express x4)" on page 10. For the proper installation of PCI Express VGA card, please refer to the installation guide on page 19.
8. For microphone input, this motherboard supports both stereo and mono modes. For audio output, this motherboard supports 2-channel, 4-channel, 6-channel, and 8-channel modes. Please check the table on page 12 for proper connection.
9. Before installing SATAII hard disk to SATAII connector, please read the "SATAII Hard Disk Setup Guide" on page 34 to adjust your SATAII hard disk drive to SATAII mode. Besides, you are allowed to downgrade the SATAII hard disk to SATA hard disk (from SATAII 3Gb/s down to SATA 1.5Gb/s), and connect it to the SATAII connector. You can also connect SATA hard disk to SATAII connector directly.
10. This motherboard supports eSATAII interface, the external SATAII specification. Please read "eSATAII Interface Introduction" on page 31 for details about eSATAII and eSATAII installation procedures. (Port Multiplier Technology is not supported with eSATAII interface on this motherboard.)
11. Power Management for USB 2.0 works fine under Microsoft® Windows® Vista™ / XP 64-bit / XP SP1 or SP2 / 2000 SP4.
12. Microsoft® Windows® Vista™ driver is not ready yet. We will update it to our website in the future. Please visit our website for Microsoft® Windows® Vista™ driver and related information.

ASRock website <http://www.asrock.com>



---

### 1.3 Minimum Hardware Requirement Table for Windows® Vista™ Premium and Basic Logo

For system integrators and users who purchase this motherboard and plan to submit Windows® Vista™ Premium and Basic logo, please follow the below table for minimum hardware requirement. Please adopt the CPU, memory, and VGA that we suggest.

CPU	Celeron D 326
Memory	512MB Single Channel
VGA	DX9.0 with WDDM Driver
	with 128bit VGA memory (Premium)
	with 64bit VGA memory (Basic)

---

## 1.4 Supported PCI Express VGA Card List for AGI Express Slot (PCI Express x4)

(for Windows® 2000/XP/XP 64-bit/Vista™)

Graphics Chip Vendor	Model Name	Chipset Name
NVIDIA	ASUS Extreme N6200GE/TD	GeForce 6200
	ASUS Extreme N6200TC256/TD	GeForce 6200
	ASUS Extreme N6800GT	GeForce 6800GT
	ASUS Extreme N6800/TD	GeForce 6800
	ASUS Extreme 7800GTX/2DHTV/256M	GeForce 7800 GTX
	Albatron PC6600GT	GeForce 6600GT
	Gigabyte GV-NX66128D	GeForce 6600
	Inno3D GeFORCE 6600 LE	GeForce 6600LE
	Leadtek PX6200 TC/TDH	GeForce 6200TC
	MSI PCX 5750-TD128E	GeForce PCX5750
	SPARKLE GeFORCE 6200TC	GeForce 6200TC
	ATI	ASUS Extreme AX600XT/HTVD
ASUS Extreme AX700PRO/TVD		RADEON X700PRO
Gecube Radeon X850XT 256M		RADEON X850XT
Gecube RX1600XTG3-D3/256M		RADEON X1600XT
Gecube RX1300PG2-D3/256M		RADEON X1300PRO
MSI RX1300GPRO-TD256E		RADEON X1300PRO
MSI RX1600GPRO-TD256E	RADEON X1600PRO	

For the latest updates of the supported PCI Express VGA card list for AGI Express slot (PCI Express x4), please visit our website for details.

ASRock website: <http://www.asrock.com/support/index.htm>

## 1.5 Motherboard Layout

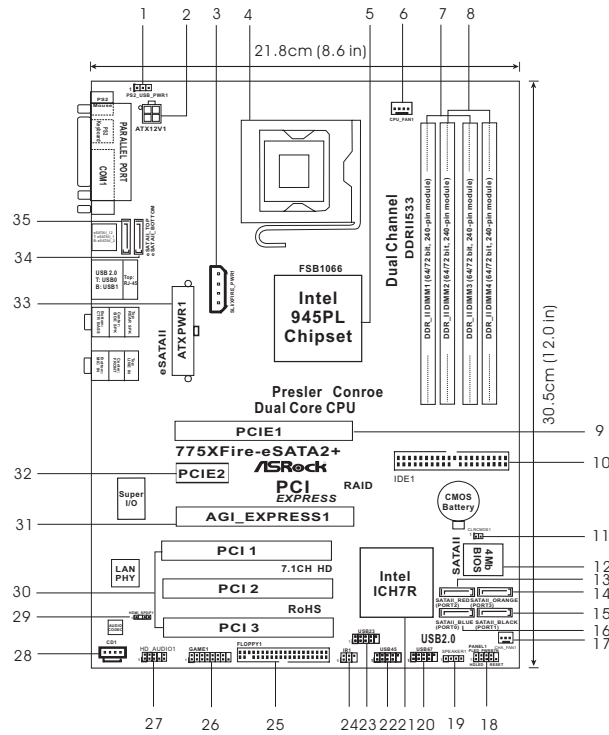

- |    |  |    |                                       |
|----|--|----|---------------------------------------|
| 1  | PS2_USB_PWR1 Jumper  | 18 | System Panel Header (PANEL1)          |
| 2  | ATX 12V Connector (ATX12V1)  | 19 | Chassis Speaker Header (SPEAKER 1)    |
| 3  | SLI / XFIRE Power Connector  | 20 | USB 2.0 Header (USB67, Blue)          |
| 4  | 775-Pin CPU Socket   | 21 | South Bridge Controller               |
| 5  | North Bridge Controller  | 22 | USB 2.0 Header (USB45, Blue)          |
| 6  | CPU Fan Connector (CPU_FAN1)   | 23 | USB 2.0 Header (USB23, Blue)          |
| 7  | 2 x 240-pin DDRII DIMM Slots<br>(Dual Channel A: DDRII_1, DDRII_3; Yellow) | 24 | Infrared Module Connector (IR1)       |
| 8  | 2 x 240-pin DDRII DIMM Slots<br>(Dual Channel B: DDRII_2, DDRII_4; Orange) | 25 | Floppy Connector (FLOPPY1)            |
| 9  | PCI Express x16 Slot (PCI1)  | 26 | Game Port Header (GAME1)              |
| 10 | IDE1 Connector (IDE1, Blue)  | 27 | Front Panel Audio Header (HD_AUDIO1)  |
| 11 | Clear CMOS Jumper (CLRCMOS1)   | 28 | Internal Audio Connector: CD1 (Black) |
| 12 | BIOS FWH Chip  | 29 | HDMI_SPDIF Header (HDMI_SPDIF1)       |
| 13 | Serial ATAII Connector (SATAII_RED (PORT2))                                | 30 | PCI Slots (PCI1-3)                    |
| 14 | Serial ATAII Connector (SATAII_ORANGE (PORT3))                             | 31 | AGI Express Slot (PCI Express x4)     |
| 15 | Serial ATAII Connector (SATAII_BLACK (PORT1))                              | 32 | PCI Express x1 Slot (PCI2)            |
| 16 | Serial ATAII Connector (SATAII_BLUE (PORT0))                               | 33 | ATX Power Connector (ATXPWR1)         |
| 17 | Chassis Fan Connector (CHA_FAN1)   | 34 | eSATAII Connector (eSATAII_BOTTOM)    |
|    |  | 35 | eSATAII Connector (eSATAII_TOP)       |

## 1.6 ASRock 8CH\_eSATAII I/O

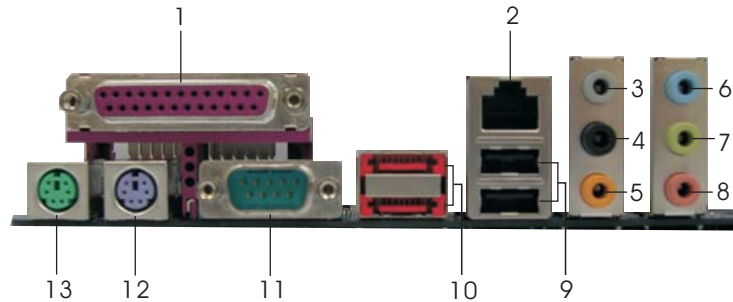

- |                           |                                |
|---------------------------|--------------------------------|
| 1 Parallel Port           | 8 Microphone (Pink)            |
| 2 RJ-45 Port              | 9 USB 2.0 Ports (USB01)        |
| 3 Side Speaker (Gray)     | 10 eSATAII Ports               |
| 4 Rear Speaker (Black)    | 11 COM Port                    |
| 5 Central / Bass (Orange) | 12 PS/2 Keyboard Port (Purple) |
| 6 Line In (Light Blue)    | 13 PS/2 Mouse Port (Green)     |
| *7 Front Speaker (Lime)   |                                |

\* If you use 2-channel speaker, please connect the speaker's plug into "Front Speaker Jack". See the table below for connection details in accordance with the type of speaker you use.

**TABLE for Audio Output Connection**

Audio Output Channels	Front Speaker (No. 7)	Rear Speaker (No. 4)	Central / Bass (No. 5)	Side Speaker (No. 3)
2	√	--	--	--
4	√	√	--	--
6	√	√	√	--
8	√	√	√	√

\* To enable Multi-Streaming function, you need to connect a front panel audio cable to the front panel audio header. After restarting your computer, you will find "Mixer" tool on your system. Please select "Mixer ToolBox" , click "Enable playback multi-streaming", and click "ok". Choose "2CH", "4CH", "6CH", or "8CH" and then you are allowed to select "Realtek HDA Primary output" to use Rear Speaker, Central/Bass, and Front Speaker, or select "Realtek HDA Audio 2nd output" to use front panel audio.

---

## Chapter 2 Installation

**775XFire-eSATA2+** is an ATX form factor (12.0" x 8.6", 30.5 x 21.8 cm) motherboard. Before you install the motherboard, study the configuration of your chassis to ensure that the motherboard fits into it.



Make sure to unplug the power cord before installing or removing the motherboard. Failure to do so may cause physical injuries to you and damages to motherboard components.

### 2.1 Screw Holes

Place screws into the holes indicated by circles to secure the motherboard to the chassis.



Do not over-tighten the screws! Doing so may damage the motherboard.

### 2.2 Pre-installation Precautions

Take note of the following precautions before you install motherboard components or change any motherboard settings.

1. Unplug the power cord from the wall socket before touching any component.
2. To avoid damaging the motherboard components due to static electricity, **NEVER** place your motherboard directly on the carpet or the like. Also remember to use a grounded wrist strap or touch a safety grounded object before you handle components.
3. Hold components by the edges and do not touch the ICs.
4. Whenever you uninstall any component, place it on a grounded antistatic pad or in the bag that comes with the component.



Before you install or remove any component, ensure that the power is switched off or the power cord is detached from the power supply. Failure to do so may cause severe damage to the motherboard, peripherals, and/or components.

## 2.3 CPU Installation

For the installation of Intel 775-LAND CPU, please follow the steps below.

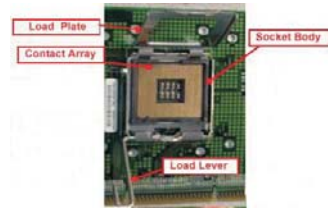

775-Pin Socket Overview



Before you insert the 775-LAND CPU into the socket, please check if the CPU surface is unclean or if there is any bent pin on the socket. Do not force to insert the CPU into the socket if above situation is found. Otherwise, the CPU will be seriously damaged.

### Step 1. Open the socket:

Step 1-1. Disengaging the lever by depressing down and out on the hook to clear retention tab.



Step 1-2. Rotate the load lever to fully open position at approximately 135 degrees.

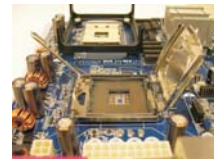

Step 1-3. Rotate the load plate to fully open position at approximately 100 degrees.

### Step 2. Insert the 775-LAND CPU:

Step 2-1. Hold the CPU by the edges where are marked with black lines.

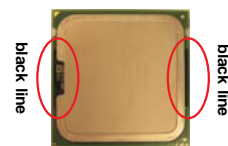

Step 2-2. Orient the CPU with IHS (Integrated Heat Sink) up. Locate Pin1 and the two orientation key notches.

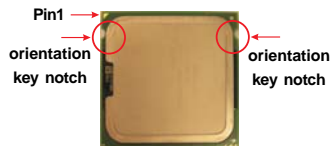

775-LAND CPU

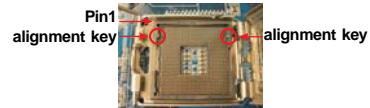

775-Pin Socket



For proper inserting, please ensure to match the two orientation key notches of the CPU with the two alignment keys of the socket.

Step 2-3. Carefully place the CPU into the socket by using a purely vertical motion.

Step 2-4. Verify that the CPU is within the socket and properly mated to the orient keys.



Step 3. Remove PnP Cap (Pick and Place Cap):

Use your left hand index finger and thumb to support the load plate edge, engage PnP cap with right hand thumb and peel the cap from the socket while pressing on center of PnP cap to assist in removal.



1. It is recommended to use the cap tab to handle and avoid kicking off the PnP cap.
2. This cap must be placed if returning the motherboard for after service.

Step 4. Close the socket:

Step 4-1. Rotate the load plate onto the IHS.

Step 4-2. While pressing down lightly on load plate, engage the load lever.

Step 4-3. Secure load lever with load plate tab under retention tab of load lever.



## 2.4 Installation of CPU Fan and Heatsink

This motherboard is equipped with 775-Pin socket that supports Intel 775-LAND CPU. Please adopt the type of heatsink and cooling fan compliant with Intel 775-LAND CPU to dissipate heat. Before you installed the heatsink, you need to spray thermal interface material between the CPU and the heatsink to improve heat dissipation. Ensure that the CPU and the heatsink are securely fastened and in good contact with each other. Then connect the CPU fan to the CPU\_FAN connector (CPU\_FAN1, see page 11, No. 6).

**For proper installation, please kindly refer to the instruction manuals of your CPU fan and heatsink.**

Below is an example to illustrate the installation of the heatsink for 775-LAND CPU.

Step 1. Apply thermal interface material onto center of IHS on the socket surface.



Step 2. Place the heatsink onto the socket. Ensure fan cables are oriented on side closest to the CPU fan connector on the motherboard (CPU\_FAN1, see page 11, No. 6).



Step 3. Align fasteners with the motherboard throughholes.

Step 4. Rotate the fastener clockwise, then press down on fastener caps with thumb to install and lock. Repeat with remaining fasteners.



If you press down the fasteners without rotating them clockwise, the heatsink cannot be secured on the motherboard.

Step 5. Connect fan header with the CPU fan connector on the motherboard.

Step 6. Secure excess cable with tie-wrap to ensure cable does not interfere with fan operation or contact other components.



## 2.5 Installation of Memory Modules (DIMM)

**775XFire-eSATA2+** motherboard provides four 240-pin DDRII (Double Data Rate II) DIMM slots, and supports Dual Channel Memory Technology. For dual channel configuration, you always need to install **identical** (the same brand, speed, size and chip-type) DDRII DIMM pair in the slots of the same color. In other words, you have to install **identical** DDRII DIMM pair in **Dual Channel A** (DDRII\_1 and DDRII\_3; Yellow slots; see p.11 No.7) or **identical** DDRII DIMM pair in **Dual Channel B** (DDRII\_2 and DDRII\_4; Orange slots; see p.11 No.8), so that Dual Channel Memory Technology can be activated. This motherboard also allows you to install four DDRII DIMMs for dual channel configuration, and please install **identical** DDRII DIMMs in all four slots. You may refer to the Dual Channel Memory Configuration Table below.

**Dual Channel Memory Configurations**  
(DS: Double Side, SS: Single Side)

	DDRII_1 (Yellow Slot)	DDRII_2 (Orange Slot)	DDRII_3 (Yellow Slot)	DDRII_4 (Orange Slot)
2 memory modules	SS	X	SS	X
2 memory modules	DS	X	DS	X
2 memory modules	X	SS	X	SS
2 memory modules	X	DS	X	DS
4 memory modules	SS	SS	SS	SS



1. If you want to install two memory modules, for optimal compatibility and reliability, it is recommended to install them in the slots of the same color. In other words, install them either in the set of yellow slots (DDRII\_1 and DDRII\_3), or in the set of orange slots (DDRII\_2 and DDRII\_4).
2. If only one memory module or three memory modules are installed in the DDRII DIMM slots on this motherboard, it is unable to activate the Dual Channel Memory Technology.
3. If a pair of memory modules is NOT installed in the same Dual Channel, for example, installing a pair of memory modules in DDRII\_1 and DDRII\_2, it is unable to activate the Dual Channel Memory Technology .
4. It is not allowed to install a DDR memory module into DDRII slot; otherwise, this motherboard and DIMM may be damaged.

**Recommended Memory Configurations**  
(DS: Double Side, SS: Single Side)

	DDRII_1 (Yellow Slot)	DDRII_2 (Orange Slot)	DDRII_3 (Yellow Slot)	DDRII_4 (Orange Slot)
1 memory module	DS/SS*	X	X	X
2 memory modules	DS/SS	X	DS/SS	X
2 memory modules	X	DS/SS	X	DS/SS
3 memory modules	SS	SS	DS/SS	X
4 memory modules	SS	SS	SS	SS

\* If you only install one memory module, you can install it to any one of the four slots.

These two TRANSCEND memory modules can only be supported under the following conditions:

DRAM VENDOR	SIZE (MB)	TYPE	CELL VENDOR	CELL NO.	SINGLE SIDE / DOUBLE SIDE
TRANSCEND	256	DDRII533	SAMSUNG	K4T56083QF-ZCD5	SINGLE SIDE
TRANSCEND	512	DDRII533	INFINEON	HYB18T512800AF37	SINGLE SIDE

1. If you plan to install one above memory module, you can install it to any DDRII slot of this motherboard.
2. If you plan to install two above memory modules, it is recommended to install them either in the set of yellow slots (DDRII\_1 and DDRII\_3), or in the set of orange slots (DDRII\_2 and DDRII\_4).
3. This motherboard does not support three or four above memory modules.

### Installing a DIMM



Please make sure to disconnect power supply before adding or removing DIMMs or the system components.

- Step 1. Unlock a DIMM slot by pressing the retaining clips outward.
- Step 2. Align a DIMM on the slot such that the notch on the DIMM matches the break on the slot.

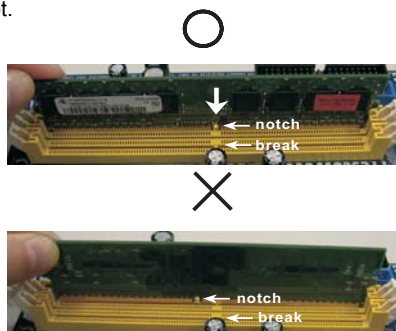



The DIMM only fits in one correct orientation. It will cause permanent damage to the motherboard and the DIMM if you force the DIMM into the slot at incorrect orientation.

- Step 3. Firmly insert the DIMM into the slot until the retaining clips at both ends fully snap back in place and the DIMM is properly seated.

## 2.6 Expansion Slots (PCI, PCI Express, and AGI Express Slots)

There are 3 PCI slots, 2 PCI Express slots, and 1 AGI Express slot (PCI Express x4) on this motherboard.

**PCI slots:** PCI slots are used to install expansion cards that have the 32-bit PCI interface.

**PCI Express Slots:** PCIE1 (PCI Express x16 slot) is used for PCI Express cards with x16 lane width graphics cards.

PCIE2 (PCI Express x1 slot) is used for PCI Express cards, such as Gigabit LAN card, SATA2 card, etc.

**AGI Express slot (PCI Express x4):**

AGI Express slot (PCI Express x4) is used to install PCI Express expansion cards. For the information of the compatible PCI Express VGA cards, please refer to the “Supported PCI Express VGA Card List for AGI Express Slot (PCI Express x4)” on page 10.

### Installing an expansion card

- Step 1. Before installing the expansion card, please make sure that the power supply is switched off or the power cord is unplugged. Please read the documentation of the expansion card and make necessary hardware settings for the card before you start the installation.
- Step 2. Remove the bracket facing the slot that you intend to use. Keep the screws for later use.
- Step 3. Align the card connector with the slot and press firmly until the card is completely seated on the slot.
- Step 4. Fasten the card to the chassis with screws.

## 2.7 CrossFire™ Operation Guide

This motherboard supports CrossFire™ feature. CrossFire™ technology offers the most advantageous means available of combining multiple high performance Graphics Processing Units (GPU) in a single PC. Combining a range of different operating modes with intelligent software design and an innovative interconnect mechanism, CrossFire™ enables the highest possible level of performance and image quality in any 3D application. Currently CrossFire™ feature is only supported with Windows® XP with Service Pack 2; it may be supported with other OS in the future.



### What graphics cards work with CrossFire™?

A complete CrossFire™ system requires a CrossFire™ Ready motherboard, a CrossFire™ Edition graphics card and a compatible standard Radeon (CrossFire™ Ready) graphics card from the same series, or two CrossFire™ Ready cards if they are software enabled. This applies to cards from ATI or any of its partners.

Cards For AGI Express Slot	Cards For PCI Express Slot
Radeon X1800 Series	Radeon X1800 CrossFire™ Edition
Radeon X1600 Series	Radeon X1600 Series
Radeon X1300 Series	Radeon X1300 Series
Radeon X850 Series	Radeon X850 CrossFire™ Edition



1. If a customer incorrectly configures their system they will not see the performance benefits of CrossFire™. All three CrossFire™ components, a CrossFire™ Ready graphics card, a CrossFire™ Ready motherboard and a CrossFire™ Edition co-processor graphics card, must be installed correctly to benefit from the CrossFire™ multi-GPU platform.
2. If you pair a 12-pipe CrossFire™ Edition card with a 16-pipe card, both cards will operate as 12-pipe cards while in CrossFire™ mode.

## Enjoy the benefit of CrossFire™



Currently, ATI has released Radeon X850XT, X1800XT, X1300, and X1600 CrossFire™ cards, which require different methods to enable CrossFire™ feature. In the below procedures, we use Radeon X850XT as the example graphics card. For other CrossFire™ cards that ATI has released or will release in the future, please refer to ATI graphics card manuals for detailed installation guide.

- Step 1. Connect to the system power supply. Please connect a hard disk power connector to SLI/XFIRE Power connector.



It is recommended to use 500-Watt power supply or greater to perform the benefit of CrossFire™ feature for Radeon X850XT.



Step 2. Install the standard Radeon (CrossFire™ Ready) graphics card to AGI Express slot (PCI Express x4). For the proper installation procedures, please refer to section "Expansion Slots".

Standard Radeon (CrossFire™ Ready) graphics card



Step 3. Install the Radeon CrossFire™ Edition graphics card to PCI Express x16 slot. For the proper installation procedures, please refer to section "Expansion Slots".

Radeon CrossFire™ Edition graphics card

Standard Radeon (CrossFire™ Ready) graphics card



You are allowed to install two CrossFire™ Edition graphics cards to both slots, or you may use one CrossFire™ Edition graphics cards and a compatible standard Radeon (CrossFire™ Ready) graphics card from the same series.

Step 4. Correctly connect the DVI-DMS cable to the monitor connector and two graphics cards that you install. (If you install two standard Radeon (CrossFire™ Ready) graphics cards to this motherboard, please skip this step.)



DVI-DMS cable



DMS connector



DVI connector

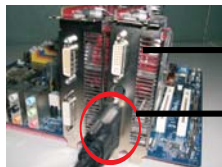

Standard Radeon (CrossFire™ Ready) graphics card

**DVI connector**

Connect the DVI-DMS cable to DVI connector of the compatible standard Radeon (CrossFire™ Ready) graphics card.



There are two DVI connectors on the standard Radeon (CrossFire™ Ready) graphics card. Please connect the DVI-DMS cable to the correct DVI connector; otherwise, the graphics card will not work.

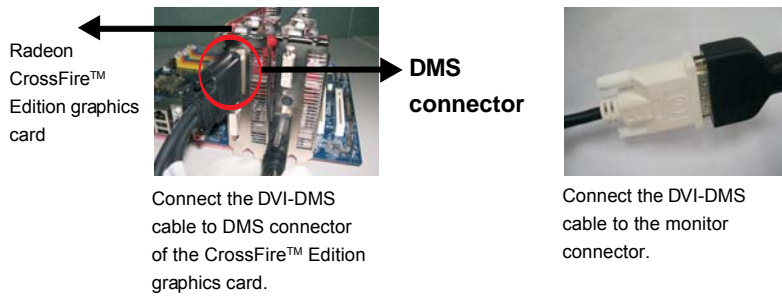

If you install two CrossFire™ Edition graphics cards to this motherboard, please connect one end of DVI-DMS cable to the monitor, another end to DMS of one of the CrossFire™ Edition graphics cards to PCI Express x 16), and the other end to DVI of another CrossFire™ Edition graphics card to AGI Express slot (PCI Express x 4). If you install one CrossFire™ Edition graphics card and one compatible standard Radeon (CrossFire™ Ready) graphics card to this motherboard, please connect one end of DVI-DMS cable to the monitor, another end to DMS of the CrossFire™ Edition graphics card, and the other end to DVI of the compatible standard Radeon (CrossFire™ Ready) graphics card.

- Step 5. Power on your computer and boot into OS.
- Step 6. Remove the ATI driver if you have any VGA driver installed in your system.



The Catalyst Uninstaller is an optional download. We recommend using this utility to uninstall any previously installed Catalyst drivers prior to installation. Please visit this website for the driver:  
<http://support.ati.com/ics/support/DLRedirect.asp?fileIDExt=050553d40196ef109fff37cbb40aaf28&accountID=737&deptID=894>

- Step 7. Install the required drivers to your system. Please visit the websites below for installing the drivers that ATI recommends:
  - A. ATI recommends Windows® XP Service Pack 2 or higher to be installed (If you have Windows® XP Service Pack 2 or higher installed in your system, there is no need to download it again):  
<http://www.microsoft.com/windowsxp/sp2/default.msp>
  - B. You must have Microsoft .NET Framework installed prior to downloading and installing the CATALYST Control Center:  
<http://www.microsoft.com/downloads/details.aspx?FamilyId=262D25E3-F589-4842-8157-034D1E7CF3A3&displaylang=en>
- Step 8. Restart your computer.

Step 9. Install the VGA card drivers to your system, and restart your computer. Then you will find “ATI Catalyst Control Center” on your desktop (ATI Catalyst driver should be version 5.10 or higher).

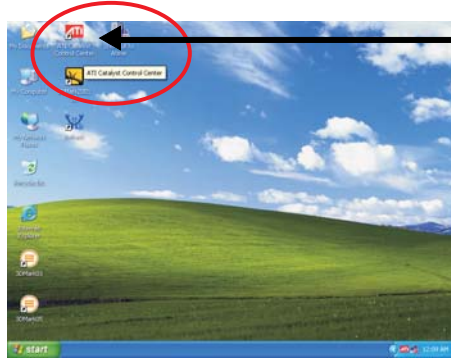

You will find “ATI Catalyst Control Center” on your desktop.

Step 10. Double-click “ATI Catalyst Control Center”. Click “View”, and select “Advanced View”. Click “CrossFire™”, and then set the option “Enable CrossFire™” to “Yes”.

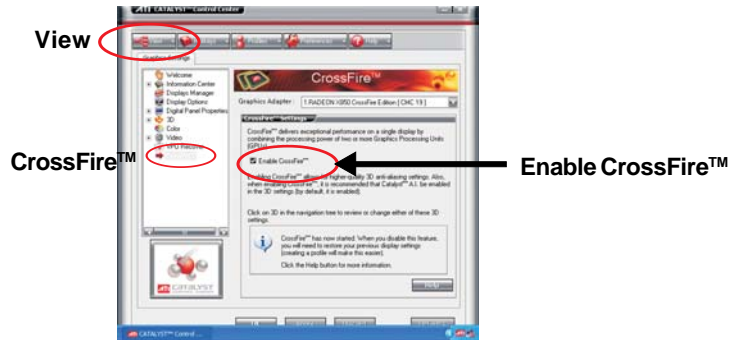

If you install one Radeon CrossFire™ Edition graphics card and one compatible standard Radeon (CrossFire™ Ready) graphics card to this motherboard but not two Radeon CrossFire™ Edition graphics cards, please as well follow the above steps. However, although you have selected the option “Enable CrossFire™”, the CrossFire™ function can not work actually. Your computer will automatically reboot. After restarting your computer, please confirm whether the option “Enable CrossFire™” in “ATI Catalyst Control Center” is selected or not; if not, please select it again, and then you are able to enjoy the benefit of CrossFire™ feature.

Step 11. You can freely enjoy the benefit of CrossFire™ feature.

\* CrossFire™ appearing here is a registered trademark of ATI Technologies Inc., and is used only for identification or explanation and to the owners' benefit, without intent to infringe.

## 2.8 Surround Display Feature

This motherboard supports Surround Display upgrade. With the external add-on PCI Express VGA card, you can easily enjoy the benefits of Surround Display feature. For the detailed instruction, please refer to the document at the following path in the Support CD:

..\ Surround Display Information

## 2.9 Jumpers Setup

The illustration shows how jumpers are setup. When the jumper cap is placed on pins, the jumper is "Short". If no jumper cap is placed on pins, the jumper is "Open". The illustration shows a 3-pin jumper whose pin1 and pin2 are "Short" when jumper cap is placed on these 2 pins.

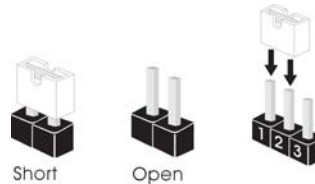

Jumper	Setting	Description
PS2_USB_PWR1 (see p.11 No. 1)	<div style="display: flex; justify-content: space-around;"> <div style="text-align: center;"> <p>1_2</p> <p>+5V</p> </div> <div style="text-align: center;"> <p>2_3</p> <p>+5VSB</p> </div> </div>	Short pin2, pin3 to enable +5VSB (standby) for PS/2 or USB wake up events.

Note: To select +5VSB, it requires 2 Amp and higher standby current provided by power supply.

Clear CMOS  
(CLRCMOS1, 2-pin jumper)  
(see p.11 No. 11)



Note: CLRCMOS1 allows you to clear the data in CMOS. The data in CMOS includes system setup information such as system password, date, time, and system setup parameters. To clear and reset the system parameters to default setup, please turn off the computer and unplug the power cord from the power supply. After waiting for 15 seconds, use a jumper cap to short 2 pins on CLRCMOS1 for 5 seconds.

## 2.10 Onboard Headers and Connectors



Onboard headers and connectors are NOT jumpers. Do NOT place jumper caps over these headers and connectors. Placing jumper caps over the headers and connectors will cause permanent damage of the motherboard!



FDD connector  
(33-pin FLOPPY1)  
(see p.11 No. 25)



↑  
the red-striped side to Pin1

Note: Make sure the red-striped side of the cable is plugged into Pin1 side of the connector.

Primary IDE connector (Blue)

(39-pin IDE1, see p.11 No. 10)

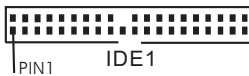

connect the blue end to the motherboard      connect the black end to the IDE devices  
80-conductor ATA 66/100 cable

Note: Please refer to the instruction of your IDE device vendor for the details.

Serial ATA II Connectors

(SATAII\_BLUE (PORT0):  
see p.11, No. 16)



SATAII\_RED



SATAII\_ORANGE

(SATAII\_BLACK (PORT1):  
see p.11, No. 15)



SATAII\_BLUE



SATAII\_BLACK

(SATAII\_RED (PORT2):  
see p.11, No. 13)

(SATAII\_ORANGE (PORT3):  
see p.11, No. 14)

These four Serial ATA II

(SATAII) connectors support SATA data cables for internal storage devices. The current SATA II interface allows up to 3.0 Gb/s data transfer rate.



SATAII\_RED (PORT2) and SATAII\_ORANGE (PORT3) connectors can be used for internal storage devices or be connected to eSATAII\_BOTTOM and eSATAII\_TOP connectors with corresponding color to support eSATAII devices. Please read "eSATAII Interface Introduction" on page 31 for details about eSATAII and eSATAII installation procedures.

eSATA II Connectors

(eSATAII\_TOP: see p.11, No. 35)

(eSATAII\_BOTTOM: see p.11, No. 34)

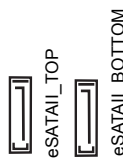

These two eSATA II

connectors support SATA data cables for external SATAII function. The current eSATA II interface allows up to 3.0 Gb/s data transfer rate.

Serial ATA (SATA)  
Data Cable



Either end of the SATA data cable can be connected to the SATA / SATAII hard disk or the SATAII connector on the motherboard. You can also use the SATA data cable to connect SATAII connectors and eSATAII connectors with corresponding color.

**Serial ATA (SATA)  
Power Cable  
(Optional)**

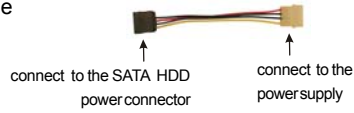

Please connect the black end of SATA power cable to the power connector on each drive. Then connect the white end of SATA power cable to the power connector of the power supply.

**USB 2.0 Headers**

(9-pin USB67)  
(see p.11 No. 20)

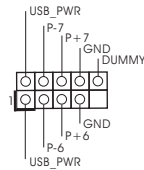

Besides two default USB 2.0 ports on the I/O panel, there are three USB 2.0 headers on this motherboard. Each USB 2.0 header can support two USB 2.0 ports.

(9-pin USB45)  
(see p.11 No. 22)

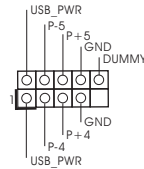

(9-pin USB23)  
(see p.11 No. 23)

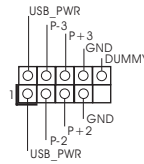

**Infrared Module Header**

(5-pin IR1)  
(see p.11 No. 24)

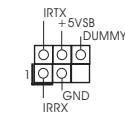

This header supports an optional wireless transmitting and receiving infrared module.

**Internal Audio Connectors**

(4-pin CD1)  
(CD1: see p.11 No. 28)

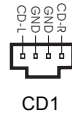

This connector allows you to receive stereo audio input from sound sources such as a CD-ROM, DVD-ROM, TV tuner card, or MPEG card.

**Front Panel Audio Header**  
 (9-pin HD\_AUDIO1)  
 (see p.11 No. 27)

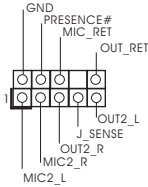

This is an interface for front panel audio cable that allows convenient connection and control of audio devices.



1. High Definition Audio supports Jack Sensing, but the panel wire on the chassis must support HDA to function correctly. Please follow the instruction in our manual and chassis manual to install your system.
2. If you use AC'97 audio panel, please install it to the front panel audio header as below:
  - A. Connect Mic\_IN (MIC) to MIC2\_L.
  - B. Connect Audio\_R (RIN) to OUT2\_R and Audio\_L (LIN) to OUT2\_L.
  - C. MIC\_RET and OUT\_RET are for HD audio panel only. You don't need to connect them for AC'97 audio panel.
  - D. Enter BIOS Setup Utility. Enter Advanced Settings, and then select Chipset Configuration. Set the Front Panel Control option from [Auto] to [Enabled].
  - E. Enter Windows system. Click the icon on the lower right hand taskbar to enter Realtek HD Audio Manager. Click "Audio I/O", select "Connector Settings" , choose "Disable front panel jack detection", and save the change by clicking "OK".

**System Panel Header**  
 (9-pin PANEL1)  
 (see p.11 No. 18)

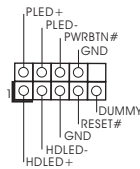

This header accommodates several system front panel functions.

**Chassis Speaker Header**  
 (4-pin SPEAKER 1)  
 (see p.11 No. 19)

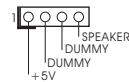

Please connect the chassis speaker to this header.

**Chassis Fan Connector**  
 (3-pin CHA\_FAN1)  
 (see p.11 No. 17)

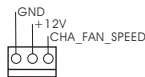

Please connect a chassis fan cable to this connector and match the black wire to the ground pin.

**CPU Fan Connector**  
 (4-pin CPU\_FAN1)  
 (see p.11 No. 6)



Please connect a CPU fan cable to this connector and match the black wire to the ground pin.

**ATX Power Connector**  
 (20-pin ATXPWR1)  
 (see p.11 No. 33)



Please connect an ATX power supply to this connector.

**ATX 12V Connector**  
 (4-pin ATX12V1)  
 (see p.11 No. 2)



Please connect an ATX 12V power supply to this connector.

**SLI/XFIRE Power Connector**  
 (4-pin SLI/XFIRE\_POWER1)  
 (see p.11 No. 3)



SLI/XFIRE\_POWER1

It is not necessary to use this connector, but please connect it with a hard disk power connector when two graphics cards are plugged to this motherboard at the same time.

**Game Port Header**  
 (15-pin GAME1)  
 (see p.11 No. 26)

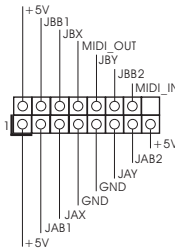

Connect a Game cable to this header if the Game port bracket is installed.

**HDMI\_SPDIF Header**  
 (3-pin HDMI\_SPDIF1)  
 (see p.11 No. 29)



HDMI\_SPDIF header, providing SPDIF audio output to HDMI VGA card, allows the system to connect HDMI Digital TV/projector/LCD devices. Please connect the HDMI connector of HDMI VGA card to this header.

**HDMI\_SPDIF Cable**  
 (Optional)

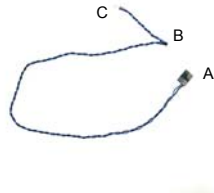

Please connect the black end (A) of HDMI\_SPDIF cable to the HDMI\_SPDIF header on the motherboard. Then connect the white end (B or C) of HDMI\_SPDIF cable to the HDMI connector of HDMI VGA card.

**A. black end**



**B. white end (2-pin)**

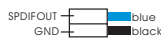

**C. white end (3-pin)**

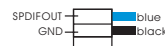



---

USB Bracket



This USB bracket can support 2 additional USB 2.0 ports besides the I/O panel. Please connect the blue connector on the cable of this USB bracket to the USB 2.0 header (USB23, USB45, or USB67) and fasten the USB bracket to the chassis with screws.



## 2.11 HDMI\_SPDIF Header Connection Guide

HDMI (High-Definition Multi-media Interface) is an all-digital audio/video specification, which provides an interface between any compatible digital audio/video source, such as a set-top box, DVD player, A/V receiver and a compatible digital audio or video monitor, such as a digital television (DTV). A complete HDMI system requires a HDMI VGA card and a HDMI ready motherboard with a HDMI\_SPDIF header. This motherboard is equipped with a HDMI\_SPDIF header, which provides SPDIF audio output to HDMI VGA card, allows the system to connect HDMI Digital TV/projector/LCD devices. To use HDMI function on this motherboard, please carefully follow the below steps.

Step 1. Install the HDMI VGA card to the PCI Express Graphics slot on this motherboard. For the proper installation of HDMI VGA card, please refer to the installation guide on page 19.

Step 2. Connect the black end (A) of HDMI\_SPDIF cable to the HDMI\_SPDIF header (HDMI\_SPDIF1, yellow, see page 11, No. 29) on the motherboard.



Make sure to correctly connect the HDMI\_SPDIF cable to the motherboard and the HDMI VGA card according to the same pin definition. For the pin definition of HDMI\_SPDIF header and HDMI\_SPDIF cable connectors, please refer to page 28. For the pin definition of HDMI\_SPDIF connectors on HDMI VGA card, please refer to the user manual of HDMI VGA card vendor. Incorrect connection may cause permanent damage to this motherboard and the HDMI VGA card.

Step 3. Connect the white end (B or C) of HDMI\_SPDIF cable to the HDMI\_SPDIF connector of HDMI VGA card. (There are two white ends (2-pin and 3-pin) on HDMI\_SPDIF cable. Please choose the appropriate white end according to the HDMI\_SPDIF connector of the HDMI VGA card you install. Currently, the HDMI\_SPDIF connector of HDMI VGA card with ATI chip is 3-pin (C), and the HDMI\_SPDIF connector of HDMI VGA card with other vendor's chip is 2-pin (B).)



white end  
(2-pin) (B)



white end  
(3-pin) (C)



Please do not connect the white end of HDMI\_SPDIF cable to the wrong connector of HDMI VGA card or other VGA card. Otherwise, the motherboard and the VGA card may be damaged. For example, this picture shows the wrong example of connecting HDMI\_SPDIF cable to the fan connector of PCI Express VGA card. Please refer to the VGA card user manual for connector usage in advance.



Step 4. Connect the HDMI output connector on HDMI VGA card to HDMI device, such as HDTV. Please refer to the user manual of HDTV and HDMI VGA card vendor for detailed connection procedures.



Step 5. Install HDMI VGA card driver to your system.

---

## 2.12 eSATAII Interface Introduction

### ***What is eSATAII?***

This motherboard supports eSATAII interface, the external SATAII specification. eSATAII allows you to enjoy the SATAII function provided by the I/O of your computer, offering the high speed data transfer rate up to 3.0Gb/s, and the convenient mobility like USB. eSATAII is equipped with Hot Plug capability that enables you to exchange drives easily. For example, with eSATAII interface, you may simply plug your eSATAII hard disk to the eSATAII ports instead of opening your chassis to exchange your SATAII hard disk. Currently, on the market, the data transfer rate of USB 2.0 is up to 480Mb/s, and for IEEE 1394 is up to 400Mb/s. However, eSATAII provides the data transfer rate up to 3000Mb/s, which is much higher than USB 2.0 and IEEE 1394, and still keeps the convenience of Hot Plug feature. Therefore, on the basis of the advantageous transfer speed and the facilitating mobile capability, in the near future, eSATAII will replace USB 2.0 and IEEE 1394 to be a trend for external interface.

### ***How to install eSATAII?***



SATAII\_RED (PORT2) and  
SATAII\_ORANGE (PORT3)



eSATAII\_TOP and  
eSATAII\_BOTTOM

1. If you just plan to install one eSATAII device to this motherboard, it is recommended to enable the bottom eSATAII port of the I/O shield. In order to enable the bottom eSATAII port of the I/O shield, you need to connect the red SATAII connector (SATAII\_RED; see p.11 No.13) and the red eSATAII connector (eSATAII\_BOTTOM; see p.11 No.34) with a SATA data cable first. Then the bottom eSATAII port of the I/O shield is enabled.



Connect the SATA  
data cable to the red  
SATAII connector  
(SATAII\_RED (PORT2))



Connect the SATA  
data cable to the red  
eSATAII connector  
(eSATAII\_BOTTOM)



2. If you plan to install two eSATAII devices to this motherboard, you need to enable both the top and the bottom eSATAII ports of the I/O shield. In order to enable the top and the bottom eSATAII ports of the I/O shield, you have to connect the red SATAII connector (SATAII\_RED; see p.11 No.13) and the red eSATAII connector (eSATAII\_BOTTOM; see p.11 No.34) with a SATA data cable first, and then connect the orange SATAII connector (SATAII\_ORANGE; see p.14 No.14) and the orange eSATAII connector (eSATAII\_TOP; see p.11 No.35) with another SATA data cable. After that, both the top and the bottom eSATAII ports of the I/O shield are enabled.



Connect the SATA data cables to both red SATAII connector (SATAII\_RED (PORT2)) and orange SATAII connector (SATAII\_ORANGE (PORT3))



Connect the SATA data cables to both red eSATAII connector (eSATAII\_BOTTOM) and orange eSATAII connector (eSATAII\_TOP)



Please make sure to correctly connect the SATAII and eSATAII connectors with corresponding color so that the eSATAII function will work successfully.

3. Use the eSATAII device cable to connect eSATAII device and the eSATAII port of the I/O shield according to the eSATAII connector that you connect the SATA data cable.



Connect one end of the eSATAII device cable to eSATAII device



Connect the other end of the eSATAII device cable to eSATAII port of the I/O shield



---

**Comparison between eSATAII and other devices**

IEEE 1394	400Mb/s
USB 2.0	480Mb/s
SATA	1.5Gb/s (1500Mb/s)
eSATAII/SATAII	3.0Gb/s (3000Mb/s)

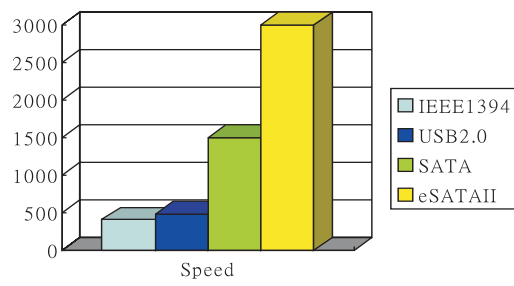

## 2.13 SATAII Hard Disk Setup Guide

Before installing SATAII hard disk to your computer, please carefully read below SATAII hard disk setup guide. Some default setting of SATAII hard disks may not be at SATAII mode, which operate with the best performance. In order to enable SATAII function, please follow the below instruction with different vendors to correctly adjust your SATAII hard disk to SATAII mode in advance; otherwise, your SATAII hard disk may fail to run at SATAII mode.

### Western Digital

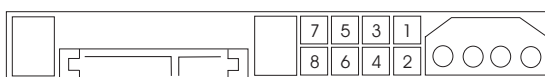

If pin 5 and pin 6 are shorted, SATA 1.5Gb/s will be enabled.

On the other hand, if you want to enable SATAII 3.0Gb/s, please remove the jumpers from pin 5 and pin 6.

### SAMSUNG



If pin 3 and pin 4 are shorted, SATA 1.5Gb/s will be enabled.

On the other hand, if you want to enable SATAII 3.0Gb/s, please remove the jumpers from pin 3 and pin 4.

### HITACHI

Please use the Feature Tool, a DOS-bootable tool, for changing various ATA features. Please visit HITACHI's website for details:

<http://www.hitachigst.com/hdd/support/download.htm>



The above examples are just for your reference. For different SATAII hard disk products of different vendors, the jumper pin setting methods may not be the same. Please visit the vendors' website for the updates.

---

## 2.14 Serial ATA (SATA) / Serial ATAII (SATAII) Hard Disks Installation

This motherboard adopts Intel® ICH7R south bridge chipset that supports Serial ATA (SATA) / Serial ATAII (SATAII) hard disks and RAID (RAID 0, RAID 1, RAID 10, RAID 5, and Intel Matrix Storage) functions. You may install SATA / SATAII hard disks on this motherboard for internal storage devices. This section will guide you to install the SATA / SATAII hard disks.

STEP 1: Install the SATA / SATAII hard disks into the drive bays of your chassis.

STEP 2: Connect the SATA power cable to the SATA / SATAII hard disk.

STEP 3: Connect one end of the SATA data cable to the motherboard's SATAII connector.

STEP 4: Connect the other end of the SATA data cable to the SATA / SATAII hard disk.



1. If you plan to use RAID 0, RAID 1, or Intel Matrix Storage function, you need to install at least 2 SATA / SATAII hard disks. If you plan to use RAID 5 function, you need to install at least 3 SATA / SATAII hard disks. If you plan to use RAID 10 function, you need to install at least 4 SATA / SATAII hard disks. If you install 2 eSATAII devices, then only RAID 0, RAID 1, or Intel Matrix Storage functions will be enabled.
2. It is not recommended to switch the "Configure SATA as" setting between AHCI, RAID, and IDE mode after OS installation.

---

## 2.15 Hot Plug and Hot Swap Functions for SATA / SATAII HDDs and eSATAII Devices

This motherboard supports Hot Plug and Hot Swap functions for SATA / SATAII / eSATAII Devices. Intel ICH7R south bridge chipset provides hardware support for Advanced Host controller Interface (AHCI), a new programming interface for SATA host controllers developed thru a joint industry effort. AHCI also provides usability enhancements such as Hot Plug. AHCI requires appropriate software support (e.g., an AHCI driver, which is contained in our support CD).



### NOTE

#### What is Hot Plug Function?

If the SATA / SATAII HDDs are NOT set for RAID configuration, it is called "Hot Plug" for the action to insert and remove the SATA / SATAII HDDs while the system is still power-on and in working condition.

However, please note that it cannot perform Hot Plug if the OS has been installed into the SATA / SATAII HDD.

#### What is Hot Swap Function?

If SATA / SATAII HDDs are built as RAID1 then it is called "Hot Swap" for the action to insert and remove the SATA / SATAII HDDs while the system is still power-on and in working condition.

eSATAII is equipped with Hot Plug capability that enables you to exchange drives easily. For example, with eSATAII interface, you may simply plug your eSATAII devices to the eSATAII ports instead of opening your chassis to exchange your SATAII hard disk.

## 2.16 Driver Installation Guide

To install the drivers to your system, please insert the support CD to your optical drive first. Then, the drivers compatible to your system can be auto-detected and listed on the support CD driver page. Please follow the order from up to bottom side to install those required drivers. Therefore, the drivers you install can work properly.

---

## 2.17 Installing Windows® 2000 / XP / XP 64-bit / Vista™ With RAID Functions

If you want to install Windows® 2000 / Windows® XP / Windows® XP 64-bit OS on your SATA HDDs with RAID functions, please follow the below steps.



The installation procedures for Windows® Vista™ are subject to change.

### STEP 1: Set up BIOS.

- A. Enter BIOS SETUP UTILITY → Advanced screen → IDE Configuration.
- B. Set “ATA/IDE Configuration” to [Enhanced], and then in the option “Configure SATA as”, please set the option to [RAID].

### STEP 2: Make a SATA Driver Diskette.

- A. Insert the Support CD into your optical drive to boot your system.
- B. During POST at the beginning of system boot-up, press <F11> key, and then a window for boot devices selection appears. Please select CD-ROM as the boot device.
- C. When you see the message on the screen, “Do you want to generate Serial ATA driver diskette [YN]?”, press <Y>.
- D. Then you will see these messages,

**Please insert a diskette into the floppy drive.**

**WARNING! Formatting the floppy diskette will lose ALL data in it!**

**Start to format and copy files [YN]?**

Please insert a floppy diskette into the floppy drive, and press <Y>.

- E. The system will start to format the floppy diskette and copy SATA drivers into the floppy diskette.

### STEP 3: Use “RAID Installation Guide” to set RAID configuration.

Before you start to configure the RAID function, you need to check the installation guide in the Support CD for proper configuration. Please refer to the document in the Support CD, “Guide to SATA Hard Disks Installation and RAID Configuration”, which is located in the folder at the following path: .. \ **RAID Installation Guide**

### STEP 4: Install Windows® 2000 / Windows® XP / Windows® XP 64-bit OS on your system.

After making a SATA driver diskette and using “RAID Installation Guide” to set RAID configuration, you can start to install Windows® 2000 / Windows® XP / Windows® XP 64-bit on your system. At the beginning of Windows setup, press F6 to install a third-party SCSI or RAID driver. When prompted, insert a floppy disk containing the Intel RAID driver. After reading the floppy disk, the driver will be presented. Select the driver to install according to the mode you choose and the OS you install. You may select: “Intel(R) 82801GR/GH SATA RAID Controller (Desktop ICH7R-Windows XP/2000)” for Windows® XP/2000 or “Intel(R) 82801GR/GH SATA RAID Controller (Desktop ICH7R-Windows XP64)” for Windows® XP 64-bit.

---

---

After the installation of Windows® 2000 / Windows® XP / Windows® XP-64bit OS, if you want to manage RAID functions, you are allowed to use both “RAID Installation Guide” and “Intel Matrix Storage Manager Information” for RAID configuration. Please refer to the document in the Support CD, “Guide to SATA Hard Disks Installation and RAID Configuration”, which is located in the folder at the following path: .. \ **RAID Installation Guide** and the document in the support CD, “Guide to Intel Matrix Storage Manager”, which is located in the folder at the following path: .. \ **Intel Matrix Storage Manager Information**



If you want to use “Intel Matrix Storage Manager” in Windows® environment, please install SATA drivers from the Support CD again so that “Intel Matrix Storage Manager” will be installed to your system as well.

### 2.17.1 Setting Up a “RAID Ready” System

You can also set up a “RAID Ready” system with a single SATA hard disk. A “RAID Ready” system can be seamlessly upgraded to RAID 0, RAID 1 or RAID 5 at a later date by using RAID migration feature of Intel Matrix Storage. The following steps outline how to build an Intel “RAID Ready” system.

1. Assemble the system and attach a single SATA hard drive.
2. Set up system BIOS as step 1 of page 37. When done, exit Setup.
3. Make a SATA driver diskette as step 2 of page 37. Begin Windows® setup by booting from the installation CD.
4. At the beginning of Windows® setup, press F6 to install a third-party SCSI or RAID driver. When prompted, insert a floppy disk containing the Intel RAID driver. After reading the floppy disk, the driver will be presented. Select the driver to install according to the mode you choose and the OS you install. You may select: “Intel(R) 82801GR/GH SATA RAID Controller (Desktop ICH7R-Windows XP/2000)” for Windows® XP/2000 or “Intel(R) 82801GR/GH SATA RAID Controller (Desktop ICH7R-Windows XP64)” for Windows® XP 64-bit.
5. Finish the Windows® installation and install all necessary drivers.
6. Install the Intel(R) Matrix Storage Manager software via the CD-ROM included with your motherboard or after downloading it from the Internet. This will add the Intel(R) Matrix Storage Console which can be used to manage the RAID configuration.
7. After setting up a “RAID Ready” system as the above steps, you can follow the procedures of the next section to migrate the system to RAID 0, RAID 1 or RAID 5.

---

## 2.17.2 Migrating a "RAID Ready" System to RAID 0, RAID 1 or RAID 5

If you have an existing "RAID Ready" system, then you can use the following steps to perform a migration from a single non-RAID configuration to a two drive RAID 0, RAID 1 configuration or three drive RAID 5 configuration. To prepare for this, you will need another SATA hard drive with a capacity equal to or greater than that currently being used as the source hard drive.

1. Physically attach one additional SATA hard drive to the SATA port not being used. Note the serial number of the hard drive already in the system; you will use this to select it as the source hard drive when initiating the migration.
2. Boot Windows®, install the Intel(R) Matrix Storage Manager software, if not already installed, using the setup package obtained from a CD-ROM or from the Internet. This will install the necessary Intel Storage Utility and start menu links.
3. Open the Intel Storage Utility from the Start Menu and select "Create RAID volume from Existing Hard Drive" from the Actions menu. This will activate the Create RAID volume from Existing Hard Drive Wizard. Click through the dialogs as prompted. It's important to understand what will occur during the migration process because any data on the destination hard drive will be lost.
4. Once the migration is complete, reboot the system. If you migrated to a RAID 0 volume, use Disk Management from within Windows® in order to partition and format the empty space created when the two hard drive capacities are combined. You may also use third-party software to extend any existing partitions within the RAID volume.

## 2.18 Installing Windows® 2000 / XP / XP 64-bit / Vista™ Without RAID Functions

If you want to install Windows® 2000 / XP / XP 64-bit on your SATA HDDs without RAID functions, please follow the below steps.



The installation procedures for Windows® Vista™ are subject to change.

### STEP 1: Set Up BIOS.

- A. Enter BIOS SETUP UTILITY → Advanced screen → IDE Configuration.
- B. Set "ATA/IDE Configuration" to [Enhanced], and then in the option "Configure SATA as", please set the option to [AHCI] or [IDE].

### STEP 2: Make a SATA Driver Diskette. (Only when you select AHCI mode and use SATA HDD.)



If you set "Configure SATA as" to [IDE], there is no need to make a SATA driver diskette. If you select [AHCI] mode and install Windows® OS on IDE drive, you do not have to make a driver diskette.

If you set "Configure SATA as" to [AHCI] mode, and plan to install Windows® 2000 / XP / XP 64-bit OS on a SATA hard disk, you have to make a SATA driver diskette. Please refer to step 2 on page 37 for details. (If you select AHCI mode and plan to install Windows® Vista™ on a SATA hard disk, you don't need to make a SATA driver diskette.) But if you choose [IDE] mode, please ignore this step.

**STEP 3: Install Windows® 2000 / Windows® XP / Windows® XP 64-bit OS on your system.**

After making a SATA driver diskette, you can start to install Windows® 2000 / XP / XP 64-bit on your system. At the beginning of Windows® setup, press F6 to install a third-party SCSI or RAID driver. When prompted, insert a floppy disk containing the Intel RAID driver. After reading the floppy disk, the driver will be presented. Select the driver to install according to the mode you choose and the OS you install. You may select: "Intel(R) 82801GR/GH SATA AHCI Controller (Desktop ICH7R-Windows XP/2000)" for Windows® XP/2000 or "Intel(R) 82801GR/GH SATA AHCI Controller (Desktop ICH7R-Windows XP64)" for Windows® XP 64-bit.

## 2.19 Untied Overclocking Technology

This motherboard supports Untied Overclocking Technology, which means during overclocking, FSB enjoys better margin due to fixed PCI bus. You may set "CPU Host Frequency" option of BIOS setup to [Auto], which will show you the actual CPU host frequency in the following item. Therefore, CPU FSB is untied during overclocking, but PCI bus is in the fixed mode so that FSB can operate under a more stable overclocking environment.



---

## Chapter 3 BIOS SETUP UTILITY

### 3.1 Introduction

This section explains how to use the BIOS SETUP UTILITY to configure your system. The BIOS FWH chip on the motherboard stores the BIOS SETUP UTILITY. You may run the BIOS SETUP UTILITY when you start up the computer. Please press <F2> during the Power-On-Self-Test (POST) to enter the BIOS SETUP UTILITY, otherwise, POST will continue with its test routines.

If you wish to enter the BIOS SETUP UTILITY after POST, restart the system by pressing <Ctl> + <Alt> + <Delete>, or by pressing the reset button on the system chassis. You may also restart by turning the system off and then back on.



Because the BIOS software is constantly being updated, the following BIOS setup screens and descriptions are for reference purpose only, and they may not exactly match what you see on your screen.

#### 3.1.1 BIOS Menu Bar

The top of the screen has a menu bar with the following selections:

- Main** To set up the system time/date information
- Advanced** To set up the advanced BIOS features
- H/W Monitor** To display current hardware status
- Boot** To set up the default system device to locate and load the Operating System
- Security** To set up the security features
- Exit** To exit the current screen or the BIOS SETUP UTILITY

Use <←> key or <→> key to choose among the selections on the menu bar, and then press <Enter> to get into the sub screen.

### 3.1.2 Navigation Keys

Please check the following table for the function description of each navigation key.

Navigation Key(s)	Function Description
← / →	Moves cursor left or right to select Screens
↑ / ↓	Moves cursor up or down to select items
+ / -	To change option for the selected items
<Enter>	To bring up the selected screen
<F1>	To display the General Help Screen
<F9>	To load optimal default values for all the settings
<F10>	To save changes and exit the BIOS SETUP UTILITY
<ESC>	To jump to the Exit Screen or exit the current screen

### 3.2 Main Screen

When you enter the BIOS SETUP UTILITY, the Main screen will appear and display the system overview

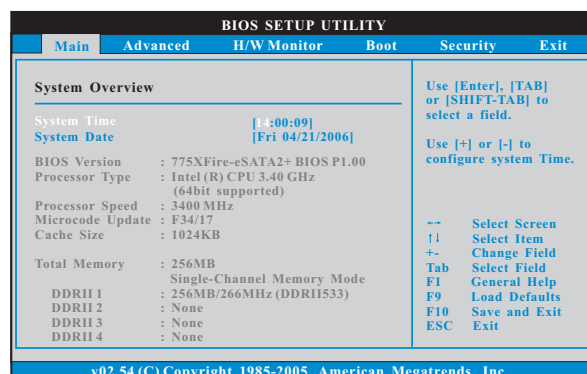

#### System Time [Hour:Minute:Second]

Use this item to specify the system time.

#### System Date [Day Month/Date/Year]

Use this item to specify the system date.

### 3.3 Advanced Screen

In this section, you may set the configurations for the following items: CPU Configuration, Chipset Configuration, ACPI Configuration, IDE Configuration, PCI PnP Configuration, Floppy Configuration, SuperIO Configuration, and USB Configuration.

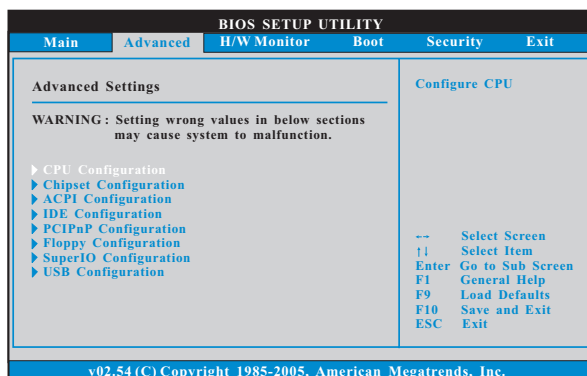

Setting wrong values in this section may cause the system to malfunction.

### 3.3.1 CPU Configuration

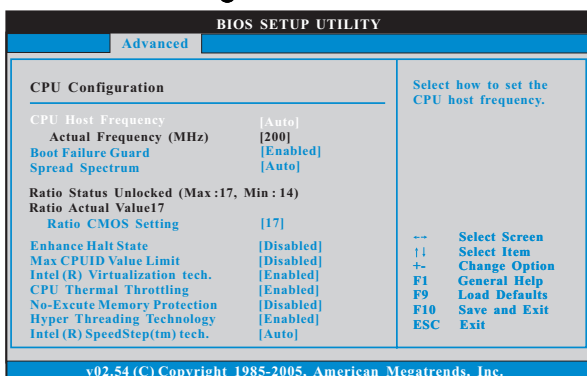

#### CPU Host Frequency

While entering setup, BIOS auto detects the present CPU host frequency of this motherboard. The actual CPU host frequency will show in the following item.

#### Boot Failure Guard

Enable or disable the feature of Boot Failure Guard.

#### Spread Spectrum

This item should always be [Auto] for better system stability.

#### Ratio Status

This is a read-only item, which displays whether the ratio status of this motherboard is "Locked" or "Unlocked". If it shows "Unlocked", you will find an item **Ratio CMOS Setting** appears to allow you changing the ratio value of this motherboard.

---

**Ratio Actual Value**

This is a read-only item, which displays the ratio actual value of this motherboard.

**Ratio CMOS Setting**

If the ratio status is unlocked, you will find this item appear to allow you changing the ratio value of this motherboard.

**Enhance Halt State**

All processors support the Halt State (C1). The C1 state is supported through the native processor instructions HLT and MWAIT and requires no hardware support from the chipset. In the C1 power state, the processor maintains the context of the system caches.

**Max CPUID Value Limit**

For Prescott CPU only, some OSes (ex. NT4.0) cannot handle the function with disable. This should be enabled in order to boot legacy OSes that cannot support CPUs with extended CPUID functions.

**Intel (R) Virtualization tech.**

When this option is set to [Enabled], a VIMM (Virtual Machine Architecture) can utilize the additional hardware capabilities provided by Vanderpool Technology. This option will be hidden if the installed CPU does not support Intel (R) Virtualization Technology.

**CPU Thermal Throttling**

You may select [Enabled] to enable P4 CPU internal thermal control mechanism to keep the CPU from overheated.

**No-Excute Memory Protection**

No-Execution (NX) Memory Protection Technology is an enhancement to the IA-32 Intel Architecture. An IA-32 processor with "No Execute (NX) Memory Protection" can prevent data pages from being used by malicious software to execute code. This option will be hidden if the current CPU does not support No-Excute Memory Protection.

**Hyper Threading Technology**

To enable this feature, it requires a computer system with an Intel Pentium®4 processor that supports Hyper-Threading technology and an operating system that includes optimization for this technology, such as Microsoft® Windows® XP. Set to [Enabled] if using Microsoft® Windows® XP, or Linux kernel version 2.4.18 or higher. This option will be hidden if the installed CPU does not support Hyper-Threading technology.

**Intel (R) SpeedStep(tm) tech.**

Intel (R) SpeedStep(tm) tech. is Intel's new power saving technology. Processor can switch between multiple frequency and voltage points to enable power savings. If you select [Auto], you need to set the "Power Schemes" as "Portable/Laptop" to enable this function.

### 3.3.2 Chipset Configuration

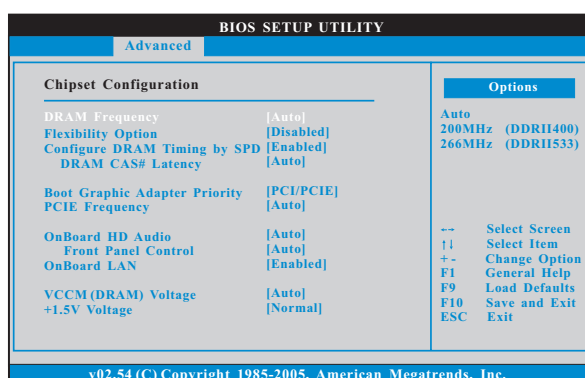

#### DRAM Frequency

If [Auto] is selected, the motherboard will detect the memory module(s) inserted and assigns appropriate frequency automatically. You may also select other value as operating frequency: [200MHz (DDR II 400)], [266MHz (DDR II 533)].

#### Flexibility Option

The default value of this option is [Disabled]. It will allow better tolerance for memory compatibility when it is set to [Enabled].

#### Configure DRAM Timing by SPD

Select [Enabled] will configure the following items by the contents in the SPD (Serial Presence Detect) device. If you select [Disabled], you will find the items "DRAM RAS# to CAS# Delay", "DRAM RAS# Precharge", and "DRAM RAS# Activate to Precharge" appear to allow you adjusting them.

#### DRAM CAS# Latency

Use this item to adjust the means of memory accessing. Configuration options are [6], [5], [4], [3], and [Auto].

#### DRAM RAS# to CAS# Delay

This controls the latency between the DRAM active command and the read / write command. Configuration options: [2 DRAM Clocks], [3 DRAM Clocks], [4 DRAM Clocks], [5 DRAM Clocks], and [6 DRAM Clocks].

#### DRAM RAS# Precharge

This controls the idle clocks after a precharge command is issued. Configuration options: [2 DRAM Clocks], [3 DRAM Clocks], [4 DRAM Clocks], [5 DRAM Clocks], and [6 DRAM Clocks].

---

**DRAM RAS# Activate to Precharge**

This controls the number of DRAM clocks for TRAS. Configuration options: [4 DRAM Clocks], [5 DRAM Clocks], [6 DRAM Clocks], [7 DRAM Clocks], [8 DRAM Clocks], [9 DRAM Clocks], [10 DRAM Clocks], [11 DRAM Clocks], [12 DRAM Clocks], [13 DRAM Clocks], [14 DRAM Clocks], and [15 DRAM Clocks].

**Boot Graphic Adapter Priority**

This allows you to select [PCI/PCIE] or [PCIE/PCI] as the boot graphic adapter priority. The default value is [PCI/PCIE].

**PCIe Frequency**

Use this option to adjust PCIe frequency. The default value is [Auto]. If you set this option to [Manual], you are allowed to adjust the actual PCIe frequency. The default value of Actual Frequency option is [100].

**OnBoard HD Audio**

Select [Auto], [Enabled] or [Disabled] for the onboard HD Audio feature. If you select [Auto], the onboard HD Audio will be disabled when PCI Sound Card is plugged.

**Front Panel Control**

Select [Auto], [Enabled] or [Disabled] for the onboard HD Audio Front Panel.

**OnBoard LAN**

This allows you to enable or disable the "OnBoard LAN" feature.

**VCCM (DRAM) Voltage**

Use this to select VCCM (DRAM) Voltage. Configuration options: [High], [Middle], [Low], and [Auto]. The default value of this feature is [Auto].

**+1.5V Voltage**

Configuration options: [High] and [Normal]. The default value of this feature is [Normal].

### 3.3.3 ACPI Configuration

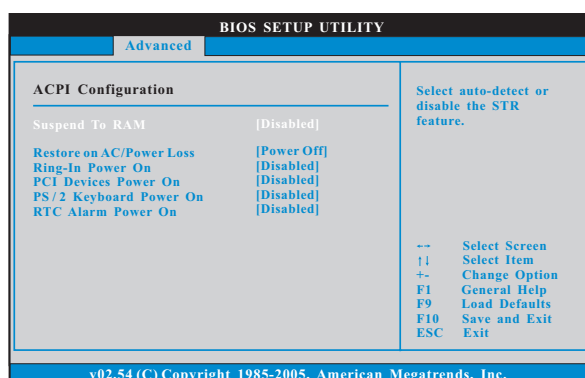

#### Suspend to RAM

This field allows you to select whether to auto-detect or disable the Suspend-to-RAM feature. Select [Auto] will enable this feature if the system supports it.

#### Restore on AC/Power Loss

This allows you to set the power state after an unexpected AC/Power loss. If [Power Off] is selected, the AC/Power remains off when the power recovers. If [Power On] is selected, the AC/Power resumes and the system starts to boot up when the power recovers.

#### Ring-In Power On

Use this item to enable or disable Ring-In signals to turn on the system from the power-soft-off mode.

#### PCI Devices Power On

Use this item to enable or disable PCI devices to turn on the system from the power-soft-off mode.

#### PS/2 Keyboard Power On

Use this item to enable or disable PS/2 keyboard to turn on the system from the power-soft-off mode.

#### RTC Alarm Power On

Use this item to enable or disable RTC (Real Time Clock) to power on the system.

### 3.3.4 IDE Configuration

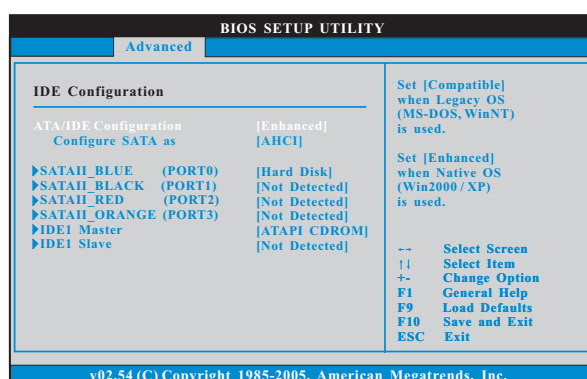

#### ATA/IDE Configuration

Please select **[Compatible]** when you install legacy OS (Windows NT). If native OS (Windows 2000 / XP) is installed, please select **[Enhanced]**. Then in the option "Configure SATA as", you are allowed to set the selection from **[AHCI]** to **[RAID]** if you plan to enable RAID function. Configuration options: **[AHCI]**, **[IDE]**, and **[RAID]**. The default value is **[AHCI]**.



1. AHCI (Advanced Host Controller Interface) supports Hot Plug, NCQ and other new features that will improve SATA disk performance but IDE mode does not have these advantages.
2. Only AHCI and RAID modes support Hot Plug function.

When **[Compatible]** is selected

#### Combined Option

It allows you to select between **[SATA0, 1, 2, 3]**, **[IDE1, SATA1, SATA3]**, and **[SATA0, SATA2, IDE1]**. If it is set to **[SATA0, SATA2, IDE1]**, then SATAII\_BLACK (PORT1), SATAII\_ORANGE (PORT3) will not work. Likewise, if it is set to **[IDE1, SATA1, SATA3]**, then SATAII\_BLUE (PORT0), SATAII\_RED (PORT2) will not work.





Because Intel® ICH7R south bridge only supports four IDE devices under legacy OS (Windows NT), you have to choose [SATA0, 1, 2, 3], [IDE1, SATA1, SATA3], and [SATA0, SATA2, IDE1] when the installed device is used with legacy OS.

	[SATA0, 1, 2, 3]	[SATA0, SATA2, IDE1]	[IDE1, SATA1, SATA3]
Master	SATAII_BLUE (PORT0), SATAII_BLACK (PORT1)	SATAII_BLUE (PORT0)	SATAII_BLACK (PORT1)
Slave	SATAII_RED (PORT2), SATAII_ORANGE (PORT3)	SATAII_RED (PORT2)	SATAII_ORANGE (PORT3)

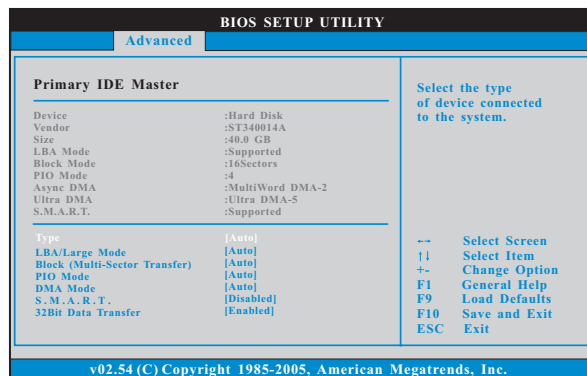

#### TYPE

Use this item to configure the type of the IDE device that you specify. Configuration options: [Not Installed], [Auto], [CD/DVD], and [ARMD].

**[Not Installed]:** Select [Not Installed] to disable the use of IDE device.

**[Auto]:** Select [Auto] to automatically detect the hard disk drive.



After selecting the hard disk information into BIOS, use a disk utility, such as FDISK, to partition and format the new IDE hard disk drives. This is necessary so that you can write or read data from the hard disk. Make sure to set the partition of the Primary IDE hard disk drives to active.

**[CD/DVD]:** This is used for IDE CD/DVD drives.

**[ARMD]:** This is used for IDE ARMD (ATAPI Removable Media Device), such as MO.

### LBA/Large Mode

Use this item to select the LBA/Large mode for a hard disk > 512 MB under DOS and Windows; for Netware and UNIX user, select [Disabled] to disable the LBA/Large mode.

### Block (Multi-Sector Transfer)

The default value of this item is [Auto]. If this feature is enabled, it will enhance hard disk performance by reading or writing more data during each transfer.

### PIO Mode

Use this item to set the PIO mode to enhance hard disk performance by optimizing the hard disk timing.

### DMA Mode

DMA capability allows the improved transfer-speed and data-integrity for compatible IDE devices.

### S.M.A.R.T.

Use this item to enable or disable the S.M.A.R.T. (Self-Monitoring, Analysis, and Reporting Technology) feature. Configuration options: [Disabled], [Auto], [Enabled].

### 32-Bit Data Transfer

Use this item to enable 32-bit access to maximize the IDE hard disk data transfer rate.

## 3.3.5 PCIPnP Configuration

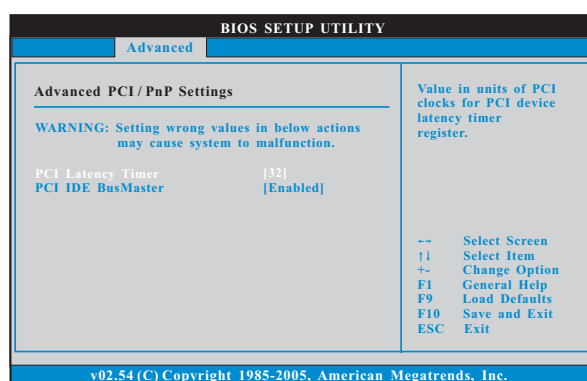

### PCI Latency Timer

The default value is 32. It is recommended to keep the default value unless the installed PCI expansion cards' specifications require other settings.

### PCI IDE BusMaster

Use this item to enable or disable the PCI IDE BusMaster feature.

### 3.3.6 Floppy Configuration

In this section, you may configure the type of your floppy drive.

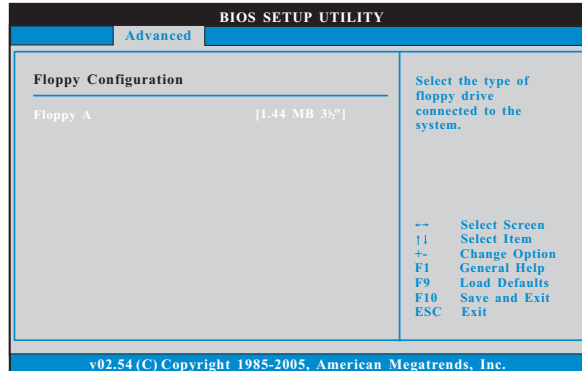

### 3.3.7 Super IO Configuration

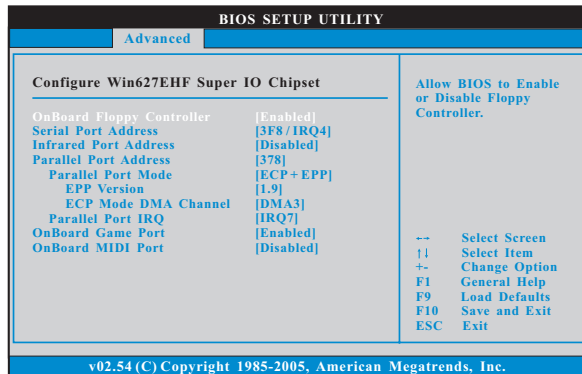

#### OnBoard Floppy Controller

Use this item to enable or disable floppy drive controller.

#### Serial Port Address

Use this item to set the address for the onboard serial port or disable it.

Configuration options: [Disabled], [3F8 / IRQ4], [2F8 / IRQ3], [3E8 / IRQ4], [2E8 / IRQ3].

#### Infrared Port Address

Use this item to set the address for the onboard infrared port or disable it.

Configuration options: [Disabled], [2F8 / IRQ3], and [2E8 / IRQ3].

---

**Parallel Port Address**

Use this item to set the address for the onboard parallel port or disable it. Configuration options: [Disabled], [378], and [278].

**Parallel Port Mode**

Use this item to set the operation mode of the parallel port. The default value is [ECP+EPP]. If this option is set to [ECP+EPP], it will show the EPP version in the following item, "EPP Version". Configuration options: [Normal], [Bi-Directional], and [ECP+EPP].

**EPP Version**

Use this item to set the EPP version. Configuration options: [1.9] and [1.7].

**ECP Mode DMA Channel**

Use this item to set the ECP mode DMA channel. Configuration options: [DMA0], [DMA1], and [DMA3].

**Parallel Port IRQ**

Use this item to set the IRQ for the parallel port. Configuration options: [IRQ5] and [IRQ7].

**OnBoard Game Port**

Use this item to enable the Game Port or disable it.

**OnBoard MIDI Port**

Use this item to select the address for the MIDI Port or disable it. Configuration options: [Disabled], [300], and [330].

### 3.3.8 USB Configuration

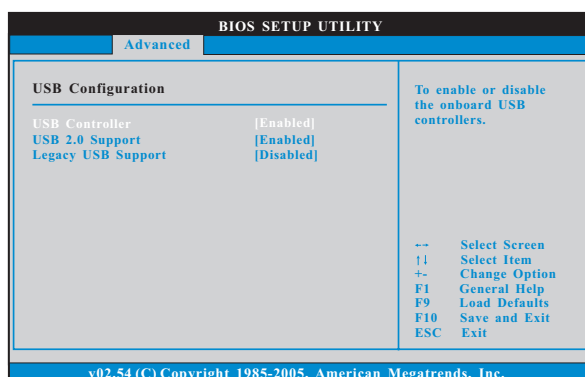

#### USB Controller

Use this item to enable or disable the use of USB controller.

#### USB 2.0 Support

Use this item to enable or disable the USB 2.0 support.

#### Legacy USB Support

Use this item to enable or disable the support to emulate legacy I/O devices such as mouse, keyboard,... etc. Or you may select [Auto] so that the system will start to auto-detect; if there is no USB device connected, "Auto" option will disable the legacy USB support.

### 3.4 Hardware Health Event Monitoring Screen

In this section, it allows you to monitor the status of the hardware on your system, including the parameters of the CPU temperature, motherboard temperature, CPU fan speed, chassis fan speed, and the critical voltage.

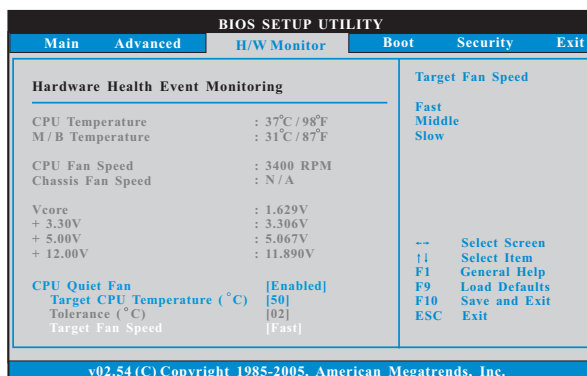

### CPU Quiet Fan

This item allows you to identify the temperature of CPU fan. If you set this option as [Disabled], the CPU fan will operate in full speed. If you set this option as [Enabled], you will find the items “Target CPU Temperature ( °C)”, “Tolerance ( °C)”, and “Minimum Fan Speed” appear to allow you adjusting them. The default value is [Disabled].

#### Target CPU Temperature ( °C)

The target temperature will be between 45 °C and 65 °C. The default value is [50].

#### Tolerance ( °C)

The default value of tolerance is [2], which means the error of the target CPU temperature will be within 2 °C.

#### Target Fan Speed

Use this option to set the target fan speed. You can freely adjust the target fan speed according to the target CPU temperature that you choose. The default value is [Fast]. Configuration options: [Fast], [Middle] and [Slow].

## 3.5 Boot Screen

In this section, it will display the available devices on your system for you to configure the boot settings and the boot priority.

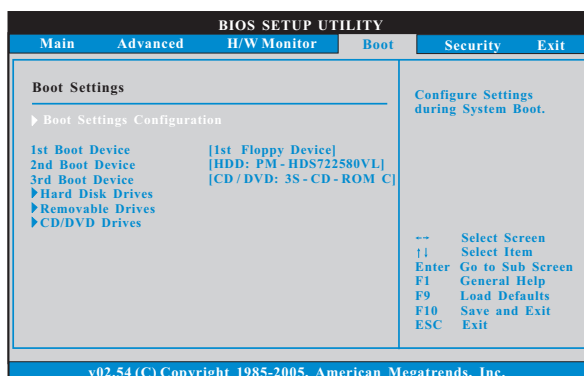

### 3.5.1 Boot Settings Configuration

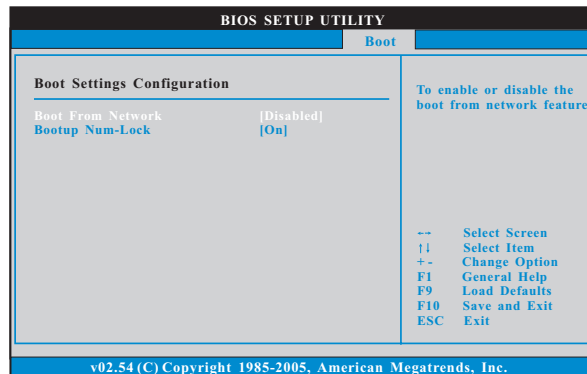

#### Boot From Network

Use this item to enable or disable the Boot From Network feature.

#### Boot Up Num-Lock

If this item is set to [On], it will automatically activate the Numeric Lock function after boot-up.

### 3.6 Security Screen

In this section, you may set or change the supervisor/user password for the system. For the user password, you may also clear it.

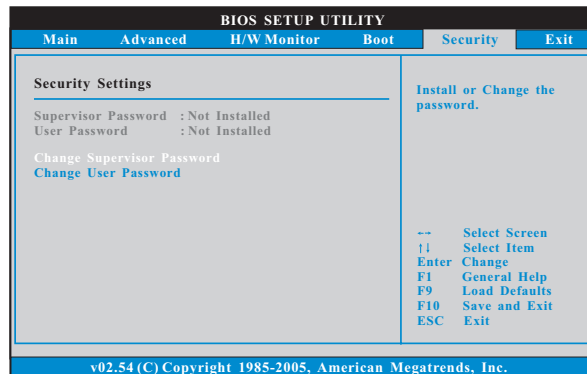

### 3.7 Exit Screen

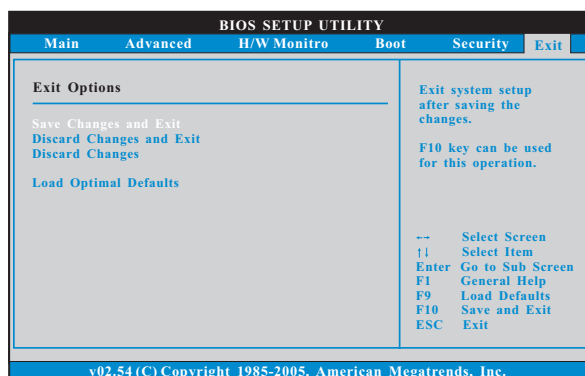

#### Save Changes and Exit

When you select this option, it will pop-out the following message, “Save configuration changes and exit setup?” Select [OK] to save the changes and exit the BIOS SETUP UTILITY.

#### Discard Changes and Exit

When you select this option, it will pop-out the following message, “Discard changes and exit setup?” Select [OK] to exit the BIOS SETUP UTILITY without saving any changes.

#### Discard Changes

When you select this option, it will pop-out the following message, “Discard changes?” Select [OK] to discard all changes.

#### Load Optimal Defaults

When you select this option, it will pop-out the following message, “Load optimal defaults?” Select [OK] to load the default values for all the setup configurations.



---

## Chapter 4 Software Support

### 4.1 Install Operating System

This motherboard supports various Microsoft® Windows® operating systems: 2000 / XP / XP 64-bit / Vista™. Because motherboard settings and hardware options vary, use the setup procedures in this chapter for general reference only. Refer to your OS documentation for more information.

### 4.2 Support CD Information

The Support CD that came with the motherboard contains necessary drivers and useful utilities that enhance the motherboard features.

#### 4.2.1 Running The Support CD

To begin using the support CD, insert the CD into your CD-ROM drive. The CD automatically displays the Main Menu if "AUTORUN" is enabled in your computer. If the Main Menu did not appear automatically, locate and double click on the file "ASSETUP.EXE" from the BIN folder in the Support CD to display the menus.

#### 4.2.2 Drivers Menu

The Drivers Menu shows the available devices drivers if the system detects installed devices. Please install the necessary drivers to activate the devices.

#### 4.2.3 Utilities Menu

The Utilities Menu shows the applications software that the motherboard supports. Click on a specific item then follow the installation wizard to install it.

#### 4.2.4 "LGA 775 CPU Installation Live Demo" Program

This motherboard is equipped with Intel LGA 775 socket, which is a new CPU socket interface that Intel has released. Since it has several tiny pins, which are easily to be damaged by improper handling, ASRock sincerely presents you a clear installation guide through this "LGA 775 CPU Installation Live Demo". We hope you may check this live demo program before you start the installation of LGA 775 CPU in order to reduce the risks of CPU and motherboard damages caused by any improper handling. To see this Live Demo, you can run Microsoft® Media Player® to play the file. You may find this Live Demo in the motherboard's Support CD through the following path:

..\ Live Demo \ PC DIY \ LGA775INST\_English.dat

#### 4.2.5 Contact Information

If you need to contact ASRock or want to know more about ASRock, welcome to visit ASRock's website at <http://www.asrock.com>; or you may contact your dealer for further information.